



The HOBO MX water level logger is used for monitoring changing water levels in a wide range of applications, including streams, lakes, wetlands, tidal areas, and groundwater. This Bluetooth® Low Energy-enabled logger is designed for wireless communication with a phone, tablet, or computer. Using the HOBOconnect® app, you can easily configure the logger and read it out—all from its deployed location—to your mobile device or computer where you can view the logged data or export it for further analysis. With the app, you can also set a reference water level and water density, configure up to 8 logging intervals, log statistics, configure an alarm to trip at thresholds you specify, or set up burst logging in which data is logged at a different interval when sensor readings are above or below certain limits. This logger features a ceramic pressure sensor, durable housing, and an integrated barometric pressure sensor for barometric compensation in the logger, which allows for direct water level readout without needing to do any post processing. An optional cap is also available for deployment in existing wells or stilling wells. Without cumbersome vent tubes or desiccants to maintain and convenient data retrieval, this easy-to-use logger is an ideal solution for water level studies and research.

## HOBO MX Water Level Logger

### Models:

- MX2001-01-SS or MX2001-01-Ti (Titanium), 9-meter/30-foot depth
- MX2001-02-SS, 30-meter/100-foot depth
- MX2001-03-SS, 76-meter/250-foot depth
- MX2001-04-SS or MX2001-04-Ti (Titanium), 4-meter/13-foot depth

Note: Each model consists of a sensor end (MX2001-0x-SS-S or MX2001-0x-Ti-S) and a top end (MX2001-TOP).

### Included Items:

- Two AA 1.5 V Batteries
- Grease packet
- 5 cm (2 inch) grommet
- Logger consisting of a top end and sensor end connected by a cable in desired length (ordered separately)

### Required Items:

- HOBOconnect app
- Mobile device with Bluetooth and iOS, iPadOS®, or Android™, or a Windows computer with a native BLE adapter or supported BLE dongle
- Cable (CABLE-DR-xxx)

### Accessory:

- Well cap (WELL-CAP-01)

## Specifications

### Pressure (Absolute) and Water Level Measurements MX2001-01-SS-S and MX2001-01-Ti-S

<b>Operation Range</b>	0 to 207 kPa (0 to 30 psia); approximately 0 to 9 m (0 to 30 ft) of water depth at sea level, or 0 to 12 m (0 to 40 ft) of water at 3,000 m (10,000 ft) of altitude
<b>Factory Calibrated Range</b>	69 to 207 kPa (10 to 30 psia), 0° to 40°C (32° to 104°F)
<b>Burst Pressure</b>	310 kPa (45 psia) or 18 m (60 ft) depth
<b>Water Level Accuracy*</b>	Typical error: ±0.05% FS, 0.5 cm (0.015 ft) water Maximum error: ±0.1% FS, 1.0 cm (0.03 ft) water
<b>Raw Pressure Accuracy**</b>	±0.3% FS, 0.62 kPa (0.09 psi) maximum error
<b>Resolution</b>	<0.02 kPa (0.003 psi), 0.21 cm (0.007 ft) water
<b>Pressure Response Time (90%***)</b>	<1 second at a stable temperature

### Pressure (Absolute) and Water Level Measurements MX2001-02-SS-S

<b>Operation Range</b>	0 to 400 kPa (0 to 58 psia); approximately 0 to 30.6 m (0 to 100 ft) of water depth at sea level, or 0 to 33.6 m (0 to 111 ft) of water at 3,000 m (10,000 ft) of altitude
<b>Factory Calibrated Range</b>	69 to 400 kPa (10 to 58 psia), 0° to 40°C (32° to 104°F)
<b>Burst Pressure</b>	500 kPa (72.5 psia) or 40.8 m (134 ft) depth
<b>Water Level Accuracy*</b>	Typical error: ±0.05% FS, 1.5 cm (0.05 ft) water Maximum error: ±0.1% FS, 3.0 cm (0.1 ft) water
<b>Raw Pressure Accuracy**</b>	±0.3% FS, 1.20 kPa (0.17 psi) maximum error
<b>Resolution</b>	<0.04 kPa (0.006 psi), 0.41 cm (0.013 ft) water
<b>Pressure Response Time (90%***)</b>	<1 second at a stable temperature

### Pressure (Absolute) and Water Level Measurements MX2001-03-SS-S

<b>Operation Range</b>	0 to 850 kPa (0 to 123.3 psia); approximately 0 to 76.5 m (0 to 251 ft) of water depth at sea level, or 0 to 79.5 m (0 to 262 ft) of water at 3,000 m (10,000 ft) of altitude
<b>Factory Calibrated Range</b>	69 to 850 kPa (10 to 123.3 psia), 0° to 40°C (32° to 104°F)
<b>Burst Pressure</b>	1,200 kPa (174 psia) or 112 m (368 ft) depth
<b>Water Level Accuracy*</b>	Typical error: ±0.05% FS, 3.8 cm (0.125 ft) water Maximum error: ±0.1% FS, 7.6 cm (0.25 ft) water
<b>Raw Pressure Accuracy**</b>	±0.3% FS, 2.55 kPa (0.37 psi) maximum error
<b>Resolution</b>	<0.085 kPa (0.012 psi), 0.87 cm (0.028 ft) water
<b>Pressure Response Time (90%***)</b>	<1 second at a stable temperature

## Specifications (continued)

### Pressure (Absolute) and Water Level Measurements MX2001-04-SS-S and MX2001-04-Ti-S

<b>Operation Range</b>	0 to 145 kPa (0 to 21 psia); approximately 0 to 4 m (0 to 13 ft) of water depth at sea level, or 0 to 7 m (0 to 23 ft) of water at 3,000 m (10,000 ft) of altitude
<b>Factory Calibrated Range</b>	69 to 145 kPa (10 to 21 psia), 0° to 40°C (32° to 104°F)
<b>Burst Pressure</b>	310 kPa (45 psia) or 18 m (60 ft) depth
<b>Water Level Accuracy*</b>	Typical error: ±0.075% FS, 0.3 cm (0.01 ft) water Maximum error: ±0.15% FS, 0.6 cm (0.02 ft) water
<b>Raw Pressure Accuracy**</b>	±0.3% FS, 0.43 kPa (0.063 psi) maximum error
<b>Resolution</b>	<0.014 kPa (0.002 psi), 0.14 cm (0.005 ft) water
<b>Pressure Response Time (90%***)</b>	<1 second at a stable temperature

### Barometric Pressure (MX2001-TOP)

<b>Operation Range</b>	66 to 107 kPa (9.57 to 15.52 psia)
<b>Temperature Calibrated Range</b>	-20 to 50°C (-4 to 122°C)
<b>Accuracy</b>	±0.2 kPa (±0.029 psi) over full temperature range at fixed pressure; maximum error ±0.5% FS
<b>Water Level Accuracy*</b>	Typical error: ±0.075% FS, 0.3 cm (0.01 ft) water Maximum error: ±0.15% FS, 0.6 cm (0.02 ft) water
<b>Resolution</b>	<0.01 kPa (0.0015 psi)
<b>Response Time</b>	<1 second at stable temperature
<b>Stability (Drift)</b>	<0.01 kPa (0.0015 psi) per year

### Temperature Measurements (All Sensor End Models MX2001-0x-SS-S and MX2001-0x-Ti-S)

<b>Operation Range</b>	-20° to 50°C (-4° to 122°F)
<b>Accuracy</b>	±0.44°C from 0° to 50°C (±0.79°F from 32° to 122°F), see Plot A
<b>Resolution</b>	0.1°C at 25°C (0.18°F at 77°F), see Plot A
<b>Response Time (90%)</b>	5 minutes in water (typical)
<b>Stability (Drift)</b>	0.1°C (0.18°F) per year

### Logger

<b>Operating Range</b>	-20° to 50°C (-4° to 122°F)
<b>Radio Power</b>	1 mW (0 dBm)
<b>Transmission Range</b>	Approximately 30.5 m (100 ft) line-of-sight
<b>Wireless Data Standard</b>	Bluetooth Low Energy (Bluetooth Smart®)
<b>Logging Rate</b>	1 second to 18 hours
<b>Logging Modes</b>	Fixed interval, multiple intervals with up to 8 user-defined logging intervals and durations, or burst
<b>Memory Modes</b>	Wrap when full or stop when full
<b>Start Modes</b>	Immediate, date & time, or next interval
<b>Stop Modes</b>	When memory full, date & time, or after a set logging period
<b>Time Accuracy</b>	±1 minute per month 0° to 50°C (32° to 122°F)
<b>Battery</b>	Two AA, 1.5 V alkaline batteries, user replaceable
<b>Battery Life</b>	1 year, typical with logging interval of 1 minute. Faster logging and/or statistics sampling intervals, entering burst logging mode, excessive readouts, checking of Full Status Details, and remaining connected with the app will impact battery life.
<b>Memory</b>	256 KB memory (30,000 sets of measurements)
<b>Full Memory Download Time</b>	Approximately 2 minutes; may take longer the further the device is from the top end of the logger
<b>Dimensions</b>	Top end (MX2001-TOP): 2.54 cm (1.0 inches) diameter, 28.9 cm (11.4 inches) length; mounting hole 7.6 mm (0.3 inches) diameter Sensor end (MX2001-0x-SS-S and MX2001-0x-Ti-S): 2.54 cm (1.0 inches) diameter, 9.91 cm (3.9 inches) length <b>Note:</b> The length of the water level logger cable (CABLE-DR-xxx) can vary -0% to +3% +10 cm (3.9 inches) from the length ordered. The logger adds 38.8 cm (15.3 inches) to the length of the cable ordered.

## Specifications (continued)

<b>Weight</b>	Top end (MX2001-TOP): Approximately 136 g (4.78 oz) in air Stainless sensor end (MX2001-0x-SS-S): Approximately 141.4 g (4.99 oz) in air; approximately 93.4 g (3.3 oz) in fresh water Titanium sensor end (MX2001-0x-Ti-S): Approximately 80 g (2.83 oz) in air; approximately 37 g (1.3 oz) in fresh water
<b>Wetted Materials</b>	Top end (MX2001-TOP): PVC housing, Polycarbonate end cap, Viton O-ring Stainless sensor end (MX2001-0x-SS-S): Stainless steel housing, Viton and Buna-N O-rings, ceramic sensor in stainless steel end cap Titanium sensor end (MX2001-0x-Ti-S): Acetal housing, Viton and Buna-N O-rings, ceramic sensor in Titanium end cap Cable (CABLE-DR-XXX): Polycarbonate strain relief (top end connection), PVC end cap (sensor connection), nylon collar nuts, Viton O-rings, polyurethane jacket
<b>Environmental Rating</b>	Top end: NEMA 6, IP67; Intermittent 100% RH Sensor end: IP68
<b>CE</b>	The CE Marking identifies this product as complying with all relevant directives in the European Union (EU).
<b>FC</b>	See last page

- \* **Water Level Accuracy:** With accurate reference water level measurement, known water density, and a stable temperature environment. System Water Level Accuracy equals the sum of the Barometric Water Level Accuracy plus the selected sensor end Water Level Accuracy.
- \*\* **Raw Pressure Accuracy:** Absolute pressure sensor accuracy includes all sensor drift, temperature, and hysteresis-induced errors.
- \*\*\* **Changes in Temperature:** Allow 20 minutes in water to achieve full temperature compensation of the pressure sensor. There can be up to 0.5% of additional error due to rapid temperature changes. Measurement accuracy also depends on temperature response time.

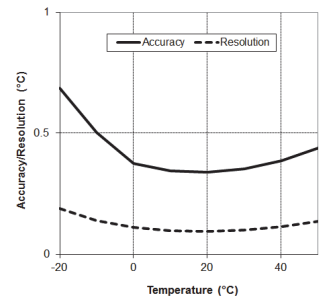

Plot A

## Logger Components and Operation

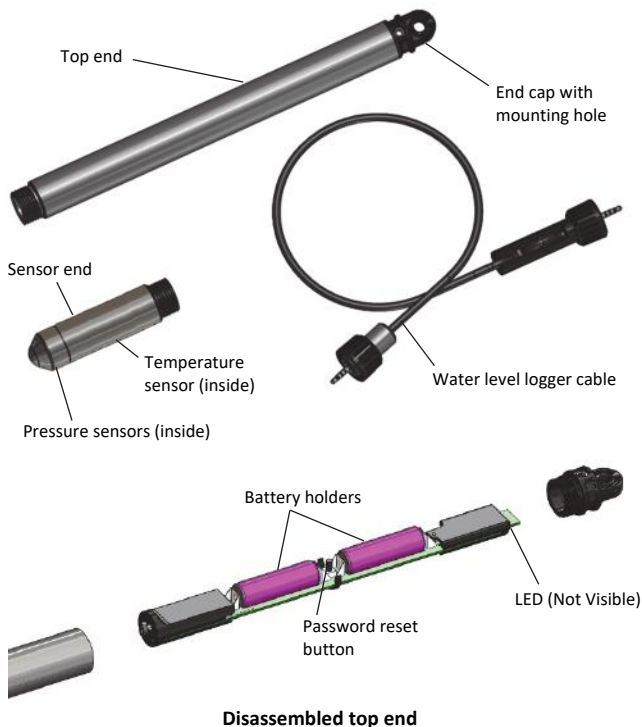

The MX water level logger consists of a top end and a sensor end that is connected by a water level logger cable. The three components work together to allow for wireless transfer of data to the app on a phone, tablet, or computer. This is an overview of each main component and the internal components in the top end:

- **Top end.** This contains the Bluetooth wireless communication and two AA batteries. This top end unit is suspended from the top of the well using the mounting hole in the end cap (see *Deploying the Logger*).
- **Sensor end.** This measures the pressure and temperature in the water. The nose cone on the sensor end houses the pressure sensors and the body of the sensor end houses the temperature sensor.
- **Water level logger cable.** This is the cable that connects the top end to the sensor end. Data measured by the sensor is transmitted through the cable to the top end where it is logged for later upload to a mobile device or computer (see *Configuring the Logger*).
- **Battery holders.** Two AA batteries are installed in the battery holders in the top end (see *Battery Information*).
- **Password reset button.** Press the button between the two batteries in the top end to reset the logger password to the factory default (see *Setting a Logger Password*).
- **LED.** Remove the end cap from the top end to view the red LED below the top edge of the circuit board. This LED blinks every second while logging and every 8 seconds

when the logger is configured to start on a specific date/time or on the next logging interval. The LED will also blink once when you press the password reset button and blink quickly multiple times when the batteries are installed.

When the three components are deployed together, you can then configure the logger or offload data to your mobile device without having to pull the logger up to the surface.

## Factory Calibration

The pressure sensors in the sensor end are individually calibrated. During calibration, raw pressure sensor data is collected at multiple pressures and temperatures over the calibrated range of the logger (see *Specifications*). This data is used to generate calibration coefficients that are stored in the sensor end's non-volatile memory. The calibration coefficients are then checked to be sure that the logger meets its stated accuracy over the calibrated range. The pressure sensor can be used at pressures and temperatures that are outside of the calibrated range, but the accuracy cannot be guaranteed.

**Important: Never exceed the burst pressure of the sensor!**

## Configuring the Logger

Follow these steps to begin using the logger. After completing steps 1–4, it is recommended that you perform a trial run of steps 5 through 12 before deploying the logger.

**Important:** When assembling the logger or attaching the cable, make sure the O-rings and mating housing surfaces are clear of any debris. Any contamination of these surfaces can cause leaks that will lead to logger failure.

- 1. Install the batteries in the top end.** See *Battery Information* for details.
- 2. Connect the logger components.** Connect the top end to the sensor end with the water level logger cable as shown below. The end of the cable with the longer housing connects to the top end as shown below.

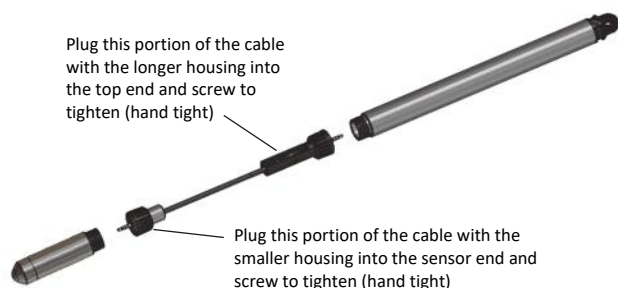

- 3. Download the app.** Download HOBObconnect to a phone or tablet from the App Store® or Google Play™ or download the app to a Windows computer from [www.onsetcomp.com/products/software/hobobconnect](http://www.onsetcomp.com/products/software/hobobconnect).
- 4. Open the app.** Enable Bluetooth in your device settings if prompted.
- 5. Determine the logger is within range.** Tap Devices. The logger should appear in the list of devices (note that the serial number shown in the app is for the top end of the logger). If the logger does not appear, make sure it is within

range of your device. Note that sensor readings are displayed as "--" when the logger is stopped.

- 6. Deploy the logger if ready.** If you are ready to deploy the logger, place it in the deployment location (see *Deploying the Logger* for deployment guidelines). Otherwise, skip deployment and complete the following steps as a test.
- 7. Connect to the logger.** Tap the logger in the app to connect to it. Tips for connecting:
  - Make sure the top end of the logger is within range of your mobile device or computer. The range for successful wireless communication is approximately 30.5 m (100 ft) with full line-of-sight.
  - If your device can connect to the logger intermittently or loses its connection, move closer to the top end of the logger, within sight if possible.
  - If the logger appears in the app, but you cannot connect to it or if you are experiencing persistent connection problems, close the app and then power down your device to force the previous Bluetooth connection to close.
- 8. Configure the logger.** Once connected to the logger, tap  to set up the logger.
- 9. Set the Reference Water Level and Water Density.**
  - Under Deployment Information, tap Reference Water Level and enter the current water level as the reference level in meters or feet. Water levels that are below the reference point should be entered as negative values. The reference water level entered will be associated with the first data point once logging begins to determine the correction factor to be used for water level data.
  - Tap water density and select one from the list for the deployment or enter your own value under Manual Input.
  - Tap Save to return to the Configuration screen.
- 10. Enable the desired sensors.** Scroll down in the Configuration screen to select the measurement parameters to be logged. Differential pressure must be enabled to calculate water level. Temperature must be enabled to log absolute pressure. Temperature must also be enabled if you selected the water density option "Fresh Water adjusted for Temp" because the temperature values are used to calculate the water density.
- 11. Finish configuring the logger.** Select any of the following logger settings as desired. The following table provides an overview of the settings. For complete details, see the app user's guide at [www.onsetcomp.com/hobobconnect](http://www.onsetcomp.com/hobobconnect).

Logger Setting	Action
Name	Enter a name for the logger (optional). If no name is entered, the logger serial number is used.
Group	Tap Group to add the logger to a group (optional). Tap Save.







Logger Setting	Action
Logging Intervals	<p>Tap Logging Intervals and select how often the logger will record data. When selecting a logging interval, keep in mind that data offload time is proportional to the amount of data logged. The faster the logging interval, the more data that will need to be offloaded and the longer it will take.</p> <p><b>Multi-Rate Logging</b> You can set a total of 8 logging intervals. After tapping Logging Intervals and entering a rate for Interval 1, tap Add to set up additional logging intervals. For each interval, enter the rate and select the number of samples that will be recorded for the selected rate. Tap Save.</p>
Start Logging Options	<p>Tap Start Logging and choose one of the following:</p> <ul style="list-style-type: none"> <li>• <b>Now.</b> Logging will begin immediately after the configuration settings are saved to the logger.</li> <li>• <b>On Next Logging Interval.</b> Logging will begin at the next even interval as determined by the selected logging interval.</li> <li>• <b>On Date/Time.</b> Logging will begin at a date and time you specify.</li> </ul> <p>Tap Save.</p>
Stop Logging Options	<p>Tap Stop Logging and choose a memory option:</p> <ul style="list-style-type: none"> <li>• <b>When Memory Fills.</b> The logger will continue recording data until the memory is full.</li> <li>• <b>Never (Wrap When Full).</b> The logger will continue recording data indefinitely, with newest data overwriting the oldest. This option is not available if the Logging Mode is set to Burst (see <i>Burst Logging</i>) or if you set up multiple logging intervals.</li> </ul> <p>Select one of the following time options for when to stop logging:</p> <ul style="list-style-type: none"> <li>• <b>Never.</b> Select this if you do not want the logger to stop at any predetermined time frame.</li> <li>• <b>On Date/Time.</b> Select this if you want the logger to stop logging on a specific date and time. Select the date and time.</li> <li>• <b>After.</b> Select this if you want to control how long the logger should continue logging once it starts. Choose the amount of time you want the logger to log data. For example, select 30 days if you want the logger to log data for 30 days after logging begins.</li> </ul> <p>Tap Save.</p>
Logging Mode and Statistics	<p>Tap Logging Mode. Choose the logging mode (note that you cannot change the logging mode if you have multiple logging intervals configured):</p> <ul style="list-style-type: none"> <li>• <b>Fixed Logging.</b> Select Normal to record the current reading for each enabled sensor at each logging interval. Note that this is also the mode you need to select for multi-rate logging. You must select Normal if you want to log water level and barometric pressure data. If you deselect Normal, the logger will only record statistics series for the enabled series. It will not be able to calculate water level or barometric pressure.</li> <li>• <b>Statistics.</b> Select any statistics you want to record (maximum, minimum, average, and</li> </ul>

Logger Setting	Action
	<p>standard deviation) and set the statistics sampling interval. Statistics are not available for water level and barometric pressure data. See <i>Statistics Logging</i> for more information.</p> <ul style="list-style-type: none"> <li>• <b>Burst Logging.</b> Select this to enable burst mode in which logging can occur at a faster rate when a specified trigger level is exceeded. See <i>Burst Logging</i> for more information.</li> </ul>
Sensors & Alarm Setup	<p>After enabling the sensors as described in step 10, set up any alarms. See <i>Setting up Alarms</i> for details.</p>

**12. Save the configuration settings.** Tap  to save the configuration settings. The logger will begin logging data based on the settings you selected. After logging begins, you can read out the logger at any time (see *Reading Out the Logger* for details). You can update the reference water level or water density during the deployment if necessary (see *Updating the Reference Water Level and Water Density*).

**Notes:**

- When the logger is stopped, the water level reading shown while connected to the logger does not reflect any reference water level and water density values you have entered (it reverts to a reference water level of zero and a water density of “Fresh Water adjusted for Temperature”). Once logging begins, the readings shown in the app will be based on the reference water level and water density you entered.
- If the logger is logging and you start a new deployment, the logger will take a current water level reading and use that as the default reference reading for the new deployment.
- These are the options available when the logger is connected to the app:

Tap this:	To do this:
	Select logger settings and save them onto the logger to start logging. See <i>Configuring the Logger</i> .
	Read out (offload) logger data. See <i>Reading Out the Logger</i> .
	Start or restart logging depending on the configuration settings selected in <i>Configuring the Logger</i> .
	Set a password for the logger that will be required if another mobile device attempts to connect to it. To reset a password, press the reset button between the batteries inside the logger or tap  and tap Reset.
	Mark the logger as a favorite. You can then filter the list of devices to only show loggers marked as favorites.
	Update the firmware on the logger. A logger readout will be completed automatically at the beginning of the firmware update process.

**Important:** Before updating the firmware on the logger, check the remaining battery level and make sure it is no less than 30%. Make sure you have the time to complete the entire update process, which requires that the logger remains connected to the device during the upgrade.

**Note:** Tapping this icon  is only required when using the app on an iPhone®, iPad®, or Android device.

## Deploying the Logger

The logger is designed to be easy to deploy in many environments. Follow the guidelines and steps in this section for deploying the logger.

### Guidelines for Deploying the Logger in a Well

The HOBO MX2001 logger top-end unit (MX2001-TOP) is IP67 rated; it is weatherproof, but should not be considered waterproof. It is not rated for continuous, humidity-saturated environments.

This logger includes an internal barometric sensor for barometric compensation and for calculating water level data. There is a vent with a hydrophobic membrane that allows the logger to sense barometric pressure while keeping water out. The vent will prevent water intrusion at up to a 1-meter (3.28 ft) depth for short periods of time. However, you must prevent the vent from being submerged more than 30 minutes.

The vent membrane keeps out most moisture, but deploying these loggers in a continuous, highly saturated well environment can eventually lead to condensation inside the logger. This can be further worsened by extreme temperature cycling, such as wells that are in direct sun and shallow water tables that are close to the logger.

Adequate air flow is required to ensure condensation is minimized on and around the MX2001-TOP.

For wells with normal outdoor humidity levels, drill a small hole in the side of the well cap to ensure that the pressure inside and outside the well is at equilibrium. You can also use the Onset well cap (WELL-CAP-01).

For wells with moderate humidity levels, follow one of these two options:

- Add holes for cross ventilation, using an extension pipe if needed.
- Deploy the MX2001-TOP outside the well (but not in direct sun).

For wells with sustained levels of high humidity, the barometer vent in the top-end unit must be isolated from the high humidity in the well. There are two methods to do this:

- Mount the MX2001-TOP outside the well and make sure it is shaded so that it is never in direct sun (the temperature extremes caused by being in the direct sun will reduce the accuracy). If you are deploying the logger in a 5 cm (2 inch) diameter well, use the Onset well cap (WELL-CAP-01) to route the sensor cable from the well and to suspend the sensor in the well.

- Use the included rubber grommet in a 5 cm (2 inch) diameter well to isolate the top section of the MX2001-TOP and add a ventilation area above the grommet as shown in the following example. Note that the grommet needs to be tight enough to provide a humidity barrier. Add holes to allow for cross ventilation. Drill four holes at least 3 mm or 1/8 inch in diameter at 90 degrees around the pipe, positioned just above the grommet to drain any water that enters the top section. Additional grommets are available at [www.onsetcomp.com](http://www.onsetcomp.com) (part number GROMMET-5).

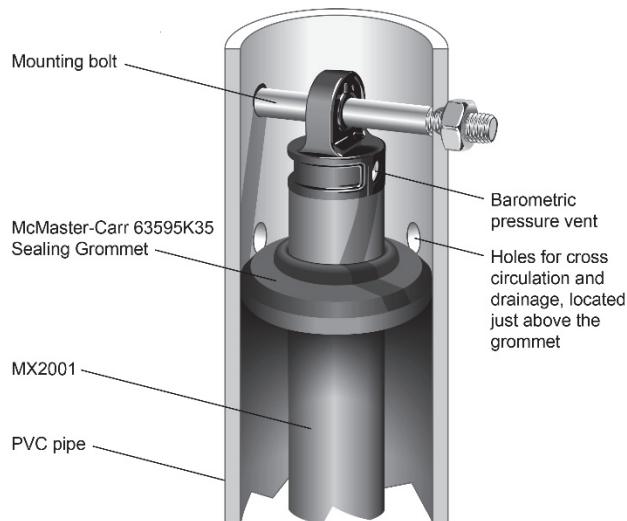

If your well must remain sealed or there is no way to avoid a continuous saturated environment, use non-vented water level loggers, such as the HOBO U20 or U20L water level loggers.

In addition, follow these guidelines when deploying the logger in a well:

- To avoid collecting water in the barometric pressure vent, hang the logger vertically and make sure the vent hole in the well cap is not oriented directly above the vent in the top end of the logger. If the logger must be mounted at an angle, the vent in the top end should point down so that any water will drain out of it.
- Consider using slots for a mounting bolt used to suspend the logger at the top of the well rather than holes so that the logger can be pulled up easily for well access without having to remove nuts in the field. This can reduce the chances for small parts falling into the water and being lost.
- The top of the logger must be close to the top of the well and not shielded in metal so that your mobile device or computer can connect to it. The maximum range for communication is 30.5 m (100 ft) with full line-of-sight.
- If you are deploying the logger in a lake, river, or stream, you must first build a stilling well to protect the logger, sensor, and cable. A simple stilling well can be constructed with PVC or ABS pipe. A properly constructed stilling well holds the sensor in position and protects the logger components from currents, wave action, and debris. Suspend the sensor end in the stilling well so it is always underwater, but not on the bottom to be buried by silt.

For more information, see the Technical Application Note for Constructing a Stilling Well at:  
[http://www.onsetcomp.com/water\\_level\\_stilling\\_well.html](http://www.onsetcomp.com/water_level_stilling_well.html)

### General Guidelines for Deploying the Logger

- The absolute pressure sensor is temperature compensated over the range of 0° to 40°C (32° to 104°F). The barometric pressure sensor is temperature compensated over the range of -20° to 50°C (-4° to 122°F). To obtain the highest level of accuracy, both the sensor end and top end units of the logger should be allowed to come to full temperature equilibrium (approximately 20 minutes) before the reference level is entered.
- Sudden temperature changes should be avoided.
- The sensor face located in the nose cone of the sensor end needs to be in the water to measure water level.

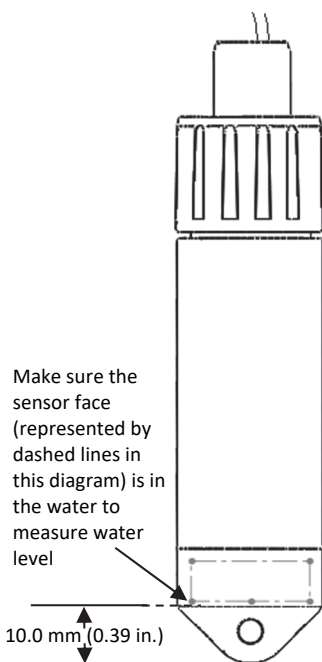

- Any change in length of the logger cable will result in a 1-to-1 corresponding error in the depth measurement. Always pull-test a cable prior to deploying a logger in a well to make sure it does not stretch.
- To prevent the sensor from moving in currents and to ensure the support cable is kept straight during deployment, you may need to add a weight to the suspension cable just above the sensor or hang a weight below the sensor. In some cases, you may need to both add a weight and use a stilling well.
- Be very careful not to exceed the burst pressure for the sensor. The pressure sensor will burst if the maximum depth is exceeded (see *Specifications*). The sensor should be positioned at a depth where it will remain in the water for the duration of the deployment, but not exceed the rated bursting depth.

- If the environment where you are deploying the logger is known to have ants that are attracted to electronics, take appropriate protective measures to protect the logger, such as using pesticides. Even though the vent membrane for the logger's barometric sensor is protected with a screen, some ants have eaten through this screen and the membrane, creating a path for moisture into the logger.
- Avoid deploying the top-end unit in direct sun as that can lead to more rapid temperature swings, which can lead to more measurement error and possibly hurt logger reliability.

To deploy the logger:

1. Make sure the top end is connected to the sensor end with the water level logger cable as described in *Getting Started with the Logger*.
2. Attach any small parts, such as bolts with nuts, before you go into the field so you don't risk losing them in the field.
3. Lower the logger into the well or stilling well.
4. Use the Onset well cap if it is a 5 cm (2 inch) well. Otherwise, use a 1/4-inch bolt of sufficient length to span the well top or washer. Mount the logger as follows:
  - The top end must be above any metal well to ensure good wireless transmission.
  - Make sure there is access for measuring the water level in the well. In some cases, such as when using the Onset well cap, it will be necessary to pull the top end of the logger out of the well to get a water level meter sensor into the well.
  - Make sure the logger cannot accidentally fall in the well.
  - If the cable is too long, loop the cable and secure the cable with multiple zip ties to ensure the loop does not slip. The looped cable should be tight enough that the cable can be easily pulled out of the well if necessary, but it must not bend the cable any tighter than a 1.25 cm (0.5 inch) radius to prevent damage to the cable.
5. Measure the water level from the desired reference point (top of pipe, ground level, or sea level) and enter it in the app. Note that you may need to pull the top end out of the well to gain access for measuring the water level within the well. Follow these guidelines for determining the reference level:
  - To maximize accuracy, allow 20 minutes after deploying the logger before measuring water depth to allow the logger to reach temperature equilibrium with the water.
  - If the well is too small in diameter to measure the water depth while the logger is deployed, measure the water depth before deployment, then deploy the logger immediately.

- If the water level surface is below the reference point as shown below, enter the reference water level in the app as a negative number.

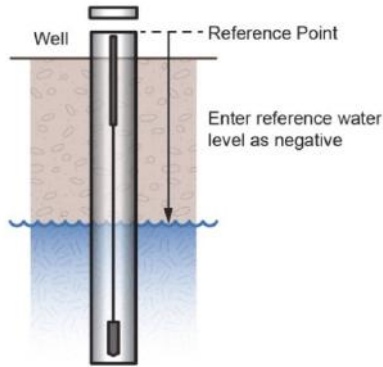

- If the water level surface is above the reference point as shown below, enter the reference water level in the app as a positive number.

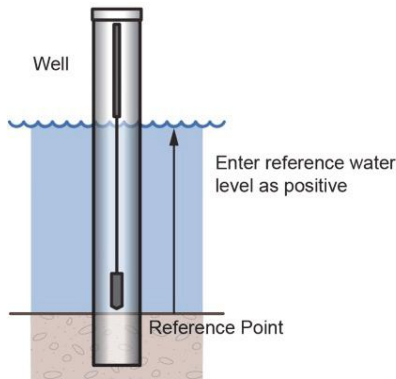

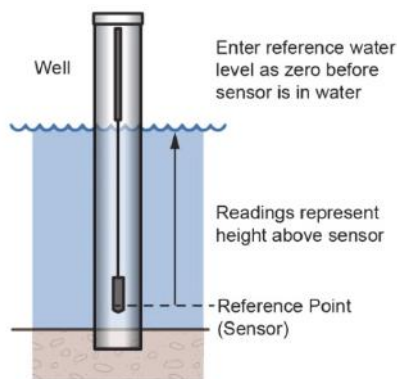

- If you are using the sensor as the reference point as shown below, enter the reference water level in the app as zero and start the logger before the sensor is in the water. The logged water level readings will represent the height above the sensor.



## Setting up Alarms

You can set an alarm to trip on the logger when a sensor reading rises above or falls below a specified value. This can alert you to problems so you can take corrective action. To set an alarm:

1. Tap Devices. Tap the logger in the app to connect to it and tap .
2. If you are going to set up a water level alarm, you must enter the reference water level and water density before setting the alarm levels.
3. Tap the Differential Pressure sensor if you want to set a water level alarm. Tap the Temperature sensor to set a temperature alarm. You cannot configure alarms for absolute pressure. Note: The fixed logging mode must be set to normal to configure a water level alarm.
4. Select High if you want an alarm to trip when the sensor reading rises above the high alarm value. Drag the slider or type a value to set the high alarm value. If you are configuring a water level alarm, enter the limit value for water level and app will show the differential pressure level that will be used to trigger the alarm in the logger.
5. Select Low if you want an alarm to trip when the sensor reading falls below the low alarm value. Drag the slider or type a value to set the low alarm value.
6. For the Duration, select how much time should elapse before the alarm trips and select one of the following:
7. Cumulative. The alarm will trip once the sensor reading is out of the acceptable range for the selected duration any time during logging. For example, if the high alarm is set to 85°F and the duration is set to 30 minutes, then the alarm will trip once the sensor readings have been above 85°F for a total of 30 minutes since the logger was configured.
8. Consecutive. The alarm will trip once the sensor reading is out of the acceptable range continuously for the selected duration. For example, the high alarm is set to 85°F and the duration is set to 30 minutes, then the alarm will only trip if all sensor readings are 85°F or above for a continuous 30-minute period.
9. Tap Save and repeat steps 3–8 for the other sensor if desired.
10. Back in the Configuration settings, the Sensor in Limits alarm option should be enabled. This indicates the alarm icon will remain visible in the app until the sensor reading returns to the normal range between any configured high and low alarm limits.
11. Tap .

### Notes:

- The actual values for the high and low alarm limits are set to the closest value supported by the logger. In addition, alarms can trip or clear when the sensor reading is within the resolution specifications. This means the value that triggers the alarm may differ slightly than the value entered.
- When setting water level alarm limits, make sure that the water level remains constant from the time alarm limits are set until the time the logger is started.
- If you need to change the reference water level during the deployment, you will also need to re-enter the alarm limits based on the new reference water level.





- The alarm icon will appear in the app next to the logger name or serial number when the alarm trips if the device is within range of the logger.
- Once an alarm condition clears, the alarm icon in the app will go away. There is no option to keep the alarm icon visible until the logger is reconfigured.
- When you read out the logger, alarm events can be displayed on the plot or in the data file. See *Logger Events*.

## Burst Logging

Burst logging is a logging mode that allows you to set up more frequent logging when a specified condition is met. For example, a logger is recording data at a 5-minute logging interval and burst logging can be configured to log every 30 seconds when the water temperature rises above 85°F (the high limit) or falls below 32°F (the low limit). This means the logger will record data every 5 minutes as long as the water temperature remains between 85°F and 32°F. Once the water temperature rises above 85°F, the logger will switch to the faster logging rate and record data every 30 seconds until the temperature falls back to 85°F. At that time, logging then resumes every 5 minutes at the normal logging interval. Similarly, if the temperature falls below 32°F, then the logger would switch to burst logging mode again and record data every 30 seconds. Once the water temperature rises back to 32°F, the logger will then return to normal mode, logging every 5 minutes. **Note:** Sensor alarms, statistics, and the Stop Logging option “Wrap When Full” are not available in burst logging mode.

To set up burst logging:

1. Tap Devices. Tap the logger in the app to connect to it and tap .
2. If you are going to set up burst logging for water level, you must enter the reference water level and water density before setting the burst limits.
3. Tap Logging Mode and then tap Burst Logging.
4. Select Low and/or High and either type or drag the slider to set the low and/or high values. If you are configuring burst logging for water level, enter the limit value for water level and the app will show the differential pressure level that will be used to trigger burst logging in the logger.
5. Repeat step 4 for the other sensor if desired.
6. Set the burst logging interval, which must be faster than the logging interval. Keep in mind that the more frequent the burst logging rate, the greater the impact on battery life and the shorter the logging duration.
7. Tap Save.
8. Tap .

### Notes:

- Once the logger is configured, the high and low burst limits are checked once every 15 seconds. Therefore, if you set the logging interval to less than 15 seconds and the sensor reading falls outside the levels, the burst

logging will not begin until the next 15-second refresh cycle.

- If high and/or low limits have been configured for more than one sensor, then burst logging will begin when any high or low condition goes out of range. Burst logging will not end until all conditions on all sensors are back within normal range.
- The actual values for the burst logging limits are set to the closest value supported by the logger.
- When setting water level limits for burst logging mode, make sure the water level remains constant from when the burst limits are set until when the logger is started.
- If you need to change the reference water level during the deployment, you will also need to re-enter the burst limits based on the new reference water level.
- Burst logging mode can begin or end when the sensor reading is within the resolution specifications. This means the value that triggers burst logging may differ slightly than the value entered.
- Once the high or low condition clears, the logging interval time will be calculated using the last recorded data point in burst logging mode, not the last data point recorded in normal mode. For example, let's assume the logger has a 10-minute logging interval and logged a data point at 9:05. Then, the high limit was surpassed and burst logging began at 9:06. Burst logging then continued until 9:12 when the sensor reading fell back below the high limit. Now back in normal mode, the next logging interval will be 10 minutes from the last burst logging point, or 9:22 in this case. If burst logging had not occurred, the next data point would have been at 9:15.
- A New Interval event is created each time the logger enters or exits burst logging mode. See *Logger Events* for details on plotting and viewing the event.

## Statistics Logging

During fixed logging, the logger records data for enabled sensors and/or selected statistics at the logging interval selected. Statistics are calculated at a sampling rate you specify with the results for the sampling period recorded at each logging interval. The following statistics can be logged for each sensor:

- The maximum, or highest, sampled value,
- The minimum, or lowest, sampled value,
- An average of all sampled values, and
- The standard deviation from the average for all sampled values.

For example, a logger is configured with the absolute pressure, differential pressure, and water temperature sensors enabled, and the logging interval set to 5 minutes. The logging mode is set to fixed interval logging with Normal and all four statistics enabled and with a statistics sampling interval of 30 seconds. Once logging begins, the logger will measure and record the actual absolute pressure, differential pressure, and water temperature sensor values every 5 minutes as well as calculate the water level and barometric pressure. In addition, the logger will take readings for the enabled sensors every 30 seconds and

temporarily store them in memory. The logger will then calculate the maximum, minimum, average, and standard deviation using the samples gathered over the previous 5-minute period and log the resulting values. When reading out the logger, this would result in 17 data series: 5 sensor-related series (differential pressure, absolute pressure, barometric pressure, temperature, and water level with data logged every 5 minutes) plus 12 maximum, minimum, average, and standard deviation series (four for differential pressure, four for absolute pressure, and four for temperature with values calculated and logged every 5 minutes based on the 30-second sampling). Statistics are not available for barometric pressure and water level data.

To log statistics:

1. Tap Devices. Tap the logger in the app to connect to it and tap .
2. Tap Logging Mode and then select Fixed Logging.
3. Select Normal to record the current reading for each enabled sensor at the selected logging interval.

**Important:** You must select Normal if you want to log water level and barometric pressure data. If you deselect Normal, the logger will not be able to calculate water level or barometric pressure.

4. Select the statistics you want the logger to record at each logging interval: Maximum, Minimum, Average, and Standard Deviation (average is automatically enabled when selecting Standard Deviation). Statistics will be logged for all enabled sensors. In addition, the more statistics you record, the shorter the logger duration and the more memory is required.
5. Tap Statistics Sampling Interval and select the rate to use for calculating statistics. The rate must be less than, and a factor of, the logging interval. For example, if the logging interval is 1 minute and you select 5 seconds for the sampling rate, then the logger will take 12 sample readings between each logging interval (one sample every 5 seconds for a minute) and use the 12 samples to record the resulting statistics at each 1-minute logging interval. Note that the more frequent the sampling rate, the greater the impact on battery life.
6. Tap Save.
7. Tap .

You can plot the statistics series once you read out the logger. Note that the logger will always display the current sensor readings in the app even if they are not being logged.

## Updating the Reference Water Level and Water Density

The logger calculates data based on the reference water level and water density settings in the app. You may need to update these settings during deployment. These are guidelines for when to update reference water level or water density.

- The reference water level may need to be adjusted to compensate for drift (see *Compensating for Drift*) or for cable stretch in water level logger cables longer than 30

meters (100 feet). Check the reference reading in the first couple of months of deployment when using a long cable and update the reference water level as necessary. Once stabilized, you should not need to reset the reference water level for several months.



- If you realize during a deployment that the reference water level and water density you entered are not as accurate as needed, then you will need to update them.
- If you update the water density, you will also need to enter a new reference water level reading. Once the new values are entered and saved, a reading is taken and will be used to calculate a new calibration constant that will be applied to all data for the current deployment (both before and after the new values are entered).
- If you only want to change future data, then stop the current deployment, offload the data, and start a new deployment with the new water parameters.

To change the reference water level or water density:

1. Tap Devices. Tap the logger in the app to connect to it and tap .
2. Enter the current water level as the new reference water level, making sure you have selected the proper units.
3. Change the water density if needed, making sure you have selected the proper units.
4. Tap Save. The changes will take effect immediately. This will result in reference water level and water density events in the data file (see *Logger Events*).

## Reading Out the Logger

To read out the logger:



1. Tap Devices. Tap the logger in the app to connect to it.
2. Tap . The logger will read out the data to the phone, tablet, or computer.
3. Once the readout is complete, tap HOBO Files and select the file to view it.
4. Tap  (if applicable) and then  to export the data.

Data can also be uploaded automatically to HOBOLink®, Onset's web-based software, via the app or the MX gateway. For details, see the app user's guide and see the HOBOLink help for details on working with data in HOBOLink.

You can also change the reference water level, reference time, and water density in the data file as needed.

**Important:** Editing the water parameters permanently changes the data file. If you need the original data, share the data file as described above before making the changes.

To change the water parameters:



1. Tap HOBO Files and select the file.
2. Tap  (if applicable) and then .
3. Tap Reference Water Level or Water Density.
4. In the Water Parameters screen:

- Enter a new reference water level value and/or change the water level units.
  - Tap Reference Time and select a time associated with a logged data point for when the reference reading was taken. Tap Save to return to the Water Parameters screen.
  - Change the water density used for the file and/or the units.
5. Tap Save to apply these new settings to the HOBO file and graph.

## Logger Events

The logger records the following internal events to track logger operation and status. You can view events in exported files or plot events in the app.



To plot events, tap HOBO Files and select a file to open.

Tap  (if applicable) and then tap . Select the events you want to plot and tap OK.

Internal Event Name	Definition
Host Connected	The logger was connected to a mobile device.
Started	The logger received a command to start recording data from the software.
Stopped	The logger received a command to stop recording data from the software.
Reference Water Level	The reference water level for the logger has been updated. The new reference water level is listed with the event.
Water Density	The water density for the logger has been updated. The new water density value is listed with the event.
Chan <#> Alarm Tripped	A sensor alarm has tripped; <#> is the sensor number, where 1 is differential pressure (water level) and 2 is temperature.
Chan <#> Alarm Cleared	A sensor alarm has cleared; <#> is the sensor number, where 1 is differential pressure (water level) and 2 is temperature.
New Interval	The logger has entered or exited burst logging mode.
Safe Shutdown	The battery level dropped below 1.85 V; the logger performs a safe shutdown.

## Setting a Logger Password



You can assign the logger a password to prevent other devices from connecting to it. To set a password:

1. Tap Devices. Tap the logger to connect to it.
2. Tap  (if applicable) and then .
3. Type a password and then tap Set.

Only the device used to set the password can then connect to the logger without entering a password; all other devices will be required to enter the password. For example, if you set the

password for the logger with your tablet and then try to connect to the logger later with your phone, you will be required to enter the password on the phone but not with your tablet. Similarly, if anyone else attempts to connect to the logger with a different device, then they would also be required to enter the password.

To reset a password, press the reset button on the logger located between the two batteries in the top end as shown

below or connect to the logger and tap  (if applicable), then , and tap Reset.

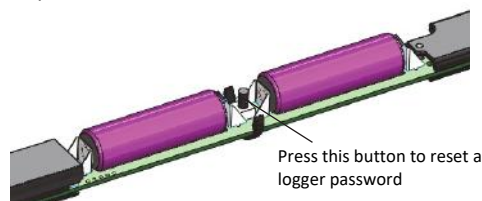

## Maintenance

The logger requires the following periodic maintenance to ensure optimal operation:

- **Protect the logger. This logger can be damaged by shock.** Always handle the top end and sensor end with care. The sensors may lose their calibrated accuracy or can be damaged if dropped. Use proper packaging when transporting or shipping the logger.

**Important: Do not attempt to open the sensor end housing!** Unscrewing the nose cone of the sensor end will cause serious damage to the pressure sensor and logger electronics. There are no user serviceable parts inside the sensor end. Contact Onset Technical Support if the sensor end requires servicing.

- **Periodically inspect the logger for biofouling.** Biological growth on the face of the pressure sensor will impact the pressure sensor's accuracy. Organisms that grow inside the sensor nose cone and on the sensor itself can interfere with the sensor's operation and eventually make the sensor unusable. If the deployment area is prone to biofouling, check the logger periodically for marine growth.
- **Be careful of solvents.** Check a materials-compatibility chart against the wetted materials listed in the Specifications table before deploying the logger in locations where untested solvents are present. The logger has Viton and Buna-N O-rings, which are sensitive to polar solvents (acetone, ketone), ammonia, chlorine, and brake fluids.

## Compensating for Drift

All pressure sensors drift over time. The drift for the pressure sensors and electronics in the logger is less than 0.5% FS (worst case) per year. In most applications, drift is not a significant source of error because the offset created by any drift is zeroed out when you enter the reference water level in the app at the beginning of each deployment. In effect, you are re-zeroing the sensor each time you apply a reference reading to the data file.

Pressure sensor drift matters more when absolute pressure values are needed, or if there are no recent reference level or depth measurements available. For example, if the logger is deployed for one year and no new reference level readings are taken during the deployment, it is possible that the sensor could have drifted as much as 0.5% FS by the end of the deployment.

It is possible to determine the actual amount of drift during a deployment if a reference level is taken at the beginning and the end of a long-term deployment. The results of applying the two different reference levels (once at the beginning of the data file and again at the end of the data file) can be compared. Any difference between the files indicates the amount of sensor drift (assuming accurate reference levels). See *Reading Out the Logger* for changing the reference water level in the data file.

## Verifying Accuracy

You can check the differential accuracy of the logger for water level measurements by deploying the logger's sensor end at two depths and comparing the difference in level readings in the data files. When verifying the accuracy this way, be sure to allow the sensor's temperature to stabilize at each depth.

You can check the absolute pressure accuracy by using the two pressure sensors in the logger. Pull up the sensor end that is in the water so that both the absolute and differential sensors are in the air. Check the differential pressure with the app. The differential pressure should be zero or less than the sum of the error for the two sensors.

## Battery Information

The logger requires two user-replaceable AA 1.5 V alkaline batteries. Expected battery life varies based on the ambient temperature where the logger is deployed, the logging or sampling interval, frequency of offloading and connection to the mobile device, number of channels that are active, alarm duration, use of burst mode or statistics logging, and battery performance. New batteries typically last 1 year with logging intervals greater than 1 minute. Deployments in extremely cold or hot temperatures, a logging interval faster than 1 minute, or a sampling interval faster than 15 seconds can impact battery life. Estimates are not guaranteed due to uncertainties in initial battery conditions and operating environment.

To install or replace the batteries:

1. Before changing the batteries, stop the logger and offload any data.
2. Disconnect the cable.
3. Unscrew the end cap on the top end. Push the board out from the cable end and then pull out the printed circuit board.

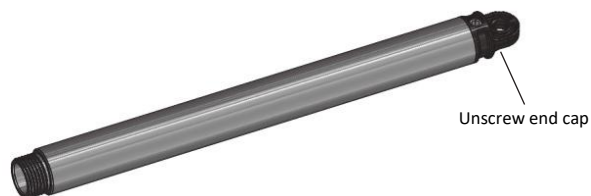

4. Remove old batteries and wipe the contacts with a lint-free cloth to clean any debris. Apply a small amount of fresh dielectric grease to the contacts and the battery terminals on the new batteries.
5. Insert two AA batteries observing polarity as shown on the board. A slight curvature in the printed circuit board is normal when the batteries are installed. Reinsert the board.

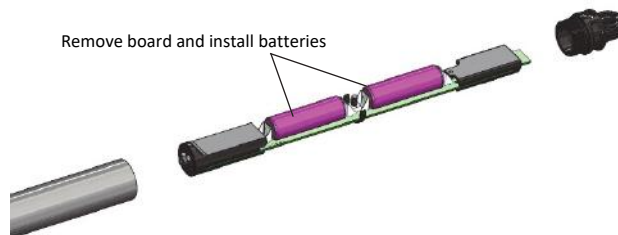

6. Inspect the gore vent on the end cap to make sure it is not damaged. Contact Onset or an Onset distributor if you need a replacement vent.
7. Inspect the O-rings and the mating surface on the logger for any damage, clean off any debris, and re-lubricate the O-rings with the grease. (You can leave the O-rings on the end cap during this process).
8. Screw the cap back on until hand tight.
9. Inspect the sensor cable connection at the opposite end before reattaching the sensor. Clean off any debris and re-lubricate the O-rings and mating surface on the sensor end with grease. (You can leave the O-rings on the end cap during this process).

**Federal Communication Commission Interference Statement**

This equipment has been tested and found to comply with the limits for a Class B digital device, pursuant to Part 15 of the FCC Rules. These limits are designed to provide reasonable protection against harmful interference in a residential installation. This equipment generates uses and can radiate radio frequency energy and, if not installed and used in accordance with the instructions, may cause harmful interference to radio communications. However, there is no guarantee that interference will not occur in a particular installation. If this equipment does cause harmful interference to radio or television reception, which can be determined by turning the equipment off and on, the user is encouraged to try to correct the interference by one of the following measures:

- Reorient or relocate the receiving antenna
- Increase the separation between the equipment and receiver
- Connect the equipment into an outlet on a circuit different from that to which the receiver is connected
- Consult the dealer or an experienced radio/TV technician for help

This device complies with Part 15 of the FCC Rules. Operation is subject to the following two conditions: (1) This device may not cause harmful interference, and (2) this device must accept any interference received, including interference that may cause undesired operation.

**FCC Caution:** Any changes or modifications not expressly approved by the party responsible for compliance could void the user's authority to operate this equipment.

**Industry Canada Statements**

This device complies with Industry Canada license-exempt RSS standard(s). Operation is subject to the following two conditions: (1) this device may not cause interference, and (2) this device must accept any interference, including interference that may cause undesired operation of the device.

**Avis de conformité pour l'Industrie Canada**

Le présent appareil est conforme aux CNR d'Industrie Canada applicables aux appareils radio exempts de licence. L'exploitation est autorisée aux deux conditions suivantes : (1) l'appareil ne doit pas produire de brouillage, et (2) l'appareil doit accepter tout brouillage radioélectrique subi, même si le brouillage est susceptible d'en compromettre le fonctionnement.

To comply with FCC and Industry Canada RF radiation exposure limits for general population, the HOBO MX logger must be installed to provide a separation distance of at least 20cm from all persons and must not be co-located or operating in conjunction with any other antenna or transmitter.

**NCC Statement**

經型式認證合格之低功率射頻電機，非經許可，公司、商號或使用者均不得擅自變更頻率、加大功率或變更原設計之特性及功能。

低功率射頻電機之使用不得影響飛航安全及干擾合法通信；經發現有干擾現象時，應立即停用，並改善至無干擾時方得繼續使用。前項合法通信，指依電信法規定作業之無線電通信。低功率射頻電機須忍受合法通信或工業、科學及醫療用電波輻射性電機設備之干擾。

**Translation:****Article 12**

Without permission granted by the NCC, any company, enterprise, or user is not allowed to change frequency, enhance transmitting power or alter original characteristic as well as performance to an approved low power radio-frequency device.

**Article 14**

The low power radio-frequency devices shall not influence aircraft security and interfere with legal communications. If found, the user shall cease operating immediately until no interference is achieved. The said legal communications means radio communications is operated in compliance with the Telecommunications Act. The low power radio-frequency devices must be susceptible with the interference from legal communications or ISM radio wave radiated devices.

**KC Statement**

해당 무선설비는 전파혼신 가능성이 있으므로 인명안전과 관련된 서비스는 할 수 없음

**Translation:**

The service related to human safety is not allowed because this device may have the possibility of the radio interference.

